

AR CONDICIONADO

MANUAL DE OPERAÇÃO

Tipo chão

Guarde este manual para consulta posterior

MANUAL DE FUNCIONAMIENTO

Tipo de Piso

Guarde este manual para poderlo consultar en el futuro

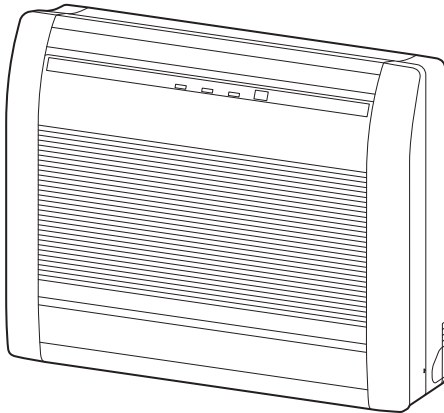



CONTENTS

SAFETY PRECAUTIONS.....	En-1	10°C HEAT OPERATION	En-12
FEATURES AND FUNCTIONS	En-2	ECONOMY OPERATION	En-12
NAME OF PARTS	En-3	SWING OPERATION	En-13
PREPARATION	En-5	MANUAL AUTO OPERATION	En-13
OPERATION.....	En-6	CLEANING AND CARE.....	En-13
TIMER OPERATION	En-8	SELECTING THE REMOTE CONTROLLER	
SLEEP TIMER OPERATION.....	En-9	SIGNAL CODE	En-16
ADJUSTING THE DIRECTION OF		TROUBLESHOOTING	En-17
AIR CIRCULATION	En-10	OPERATING TIPS.....	En-19
AIR OUTLET SELECTION.....	En-11		

SAFETY PRECAUTIONS

- Before using the appliance, read these “PRECAUTIONS” thoroughly and operate in the correct way.
- The instructions in this section all relate to safety; be sure to maintain safe operating conditions.
- “DANGER”, “WARNING” and “CAUTION” have the following meanings in these instructions:

 DANGER!	This mark indicates procedures which, if improperly performed, are most likely to result in the death of or serious injury to the user or service personnel.
 WARNING!	This mark indicates procedures which, if improperly performed, might lead to the death or serious injury of the user.
 CAUTION!	This mark indicates procedures which, if improperly performed, might possibly result in personal harm to the user, or damage to property.

WARNING!

- Do not attempt to install this air conditioner by yourself.
- This unit contains no user-serviceable parts. Always consult authorized service personnel for repairs.
- When moving, consult authorized service personnel for disconnection and installation of the unit.
- Do not become excessively chilled by staying for lengthy periods in the direct cooling airflow.
- Do not insert anything into the Airflow direction.
- Do not start and stop air conditioner operation by disconnecting the power supply cord.
- Take care not to damage the power supply cord.
- In the event of a malfunction (burning smell, etc.), immediately stop operation, disconnect the power supply plug, and consult authorized service personnel.
- If the power supply cord of this appliance is damaged, it should only be replaced by the authorized service personal, since special purpose tools and specified cord are required.
- In the event of refrigerant leakage, be sure to keep away from fire or any flammables. (consult an authorized service personnel)

CAUTION!

- Provide occasional ventilation during use.
- Do not direct airflow at fireplaces or heating apparatus.
- Do not climb on, or place objects on, the air conditioner.
- Do not hang objects from the indoor unit.
- Do not set flower vases or water containers on top of air conditioners.
- Do not expose the air conditioner directly to water.
- Do not operate the air conditioner with wet hands.
- Do not pull power supply cord.
- Turn off power source when not using the unit for extended periods.
- Check the condition of the installation stand for damage.
- Do not place animals or plants in the direct path of the airflow.
- Do not drink the water drained from the air conditioner.
- Do not use in applications involving the storage of foods, plants or animals, precision equipment, or art works.
- Connection valves become hot during Heating; handle with care.
- Do not apply any heavy pressure to radiator fins.
- Operate only with air filters installed.
- Do not block or cover the intake grille and outlet port.
- Ensure that any electronic equipment is at least 1 m away from either the indoor or outdoor units.
- Avoid installing the air conditioner near a fireplace or other heating apparatus.
- When installing the indoor and outdoor unit, take precautions to prevent access to infants.
- Do not use inflammable gases near the air conditioner.
- Do not sit and place anything on the unit.
- This appliance is not intended for use by persons (including children) with reduced physical, sensory or mental capabilities, or lack of experience and knowledge, unless they have been given supervision or instruction concerning use of the appliance by a person responsible for their safety. Children should be supervised to ensure that they do not play with the appliance.

FEATURES AND FUNCTIONS

■ Energy saving and Comfortable function

INVERTER

At the start of operation, large amount of power is used to bring the room quickly to the desired temperature. Afterwards, the unit automatically switches to a low power setting for economic and comfortable operation.

ECONOMY OPERATION

When ECONOMY operation mode is operated, the room temperature will be little higher than the set-temp under cooling mode and lower than set-temp under heating mode. Therefore, the ECONOMY mode is able to save more energy than other normal mode.

SWING OPERATION

The Airflow Direction Louvers swings automatically up and down so that the air speeds to every nook and corner of your room.

SUPER QUIET OPERATION

When the FAN button is used to select QUIET, the indoor unit begins super quiet operation; the indoor unit's airflow is reduced to produce quieter operation.

AUTO CHANGEOVER

The operation mode (cooling, dry, heating) is switched automatically to maintain the set temperature, and the temperature is kept constant at all times.

10°C HEAT OPERATION

The room temperature can be maintained at 10°C so as to prevent the room temperature from falling too far.

■ Convenient function

PROGRAM TIMER

The program timer allows you to integrate OFF timer and ON timer operations in a single sequence. The sequence can involve 1 transition from OFF timer to ON timer, or from ON timer to OFF timer, within a 24 hour period.

SLEEP TIMER

When the SLEEP timer button is pressed during heating mode, the air conditioner's thermostat setting is gradually lowered during the period of operation; during cooling or dry mode, the thermostat setting is gradually raised during the period of operation. When the set time is reached, the unit automatically turns off.

■ Clean function

REMOVABLE INTAKE GRILLE

The indoor unit's intake grille can be removed for easy cleaning and maintenance.

MILDEW-RESISTANT FILTER

The AIR FILTER has been treated to resist mildew growth, thus allowing cleaner use and easier care.

POLYPHENOL CATECHIN AIR CLEANING FILTER

The polyphenol catechin air cleaning filter uses static electricity to clean fine particles and dust in the air such as tobacco smoke and plant pollen that are too small to see. The filter contains catechin, which is highly effective against various bacteria by suppressing the growth of the bacteria adsorbed to the filter. Note that when the air cleaning filter is installed, the amount of air produced decreases, causing a slight decrease in the indoor unit's performance.

NEGATIVE AIR IONS DEODORIZING FILTER

It comprises pottery super micro particles which can produce negative air ions having the effect of deodorizing and can absorb and remit the peculiar smell at home.

■ Remote controller

WIRELESS REMOTE CONTROLLER

The wireless remote controller allows convenient control of air conditioner operation.

WIRED REMOTE CONTROLLER (OPTION)

The optional wired remote controller can be used. When you use remote controller, there are following different points as compared with using wireless remote controller.

[The additional functions for wired ones]

- Weekly timer
- Temperature set back timer

And you can use both wired and wireless remote controller simultaneously. (But function is limited)

When the restricted functions on the remote controller are used, beeping sound will be heard, OPERATION, TIMER and the 3rd lamp of the indoor unit will flash.

[The restricted functions for wireless ones]

- 10°C HEAT OPERATION
- PROGRAM TIMER
- SLEEP TIMER

NAME OF PARTS

Fig. 1

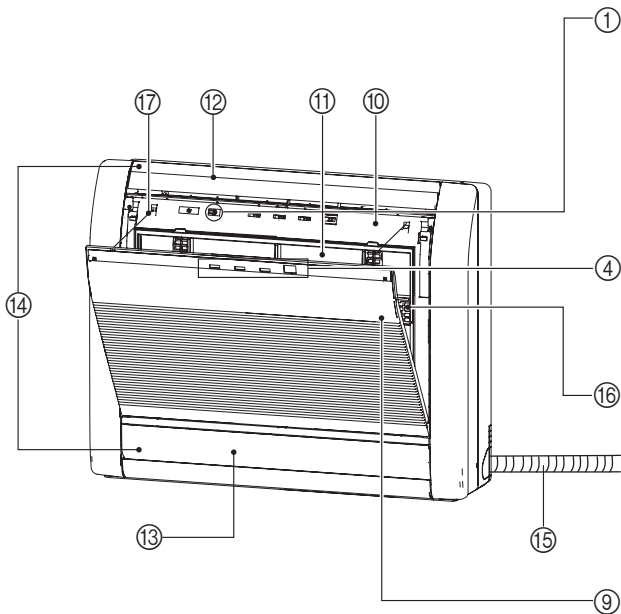

Fig. 2

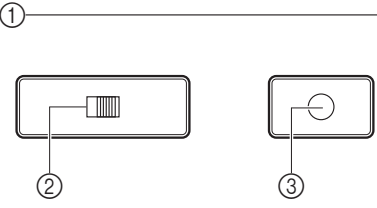

Fig. 3

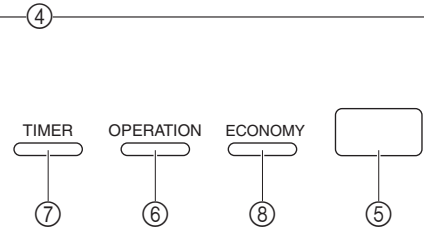

Fig. 4

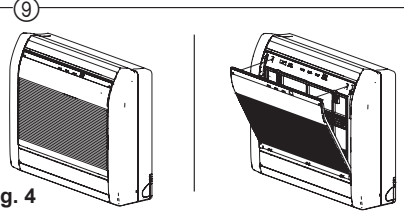

Fig. 5

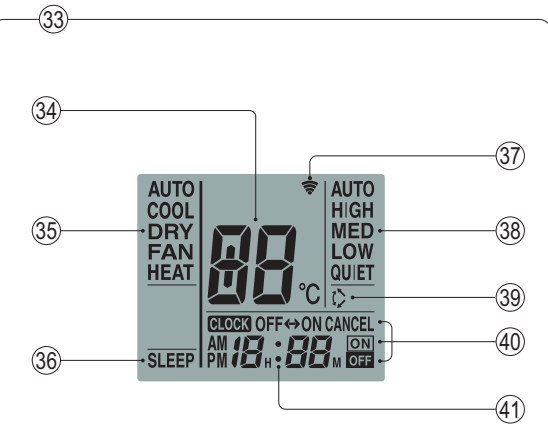
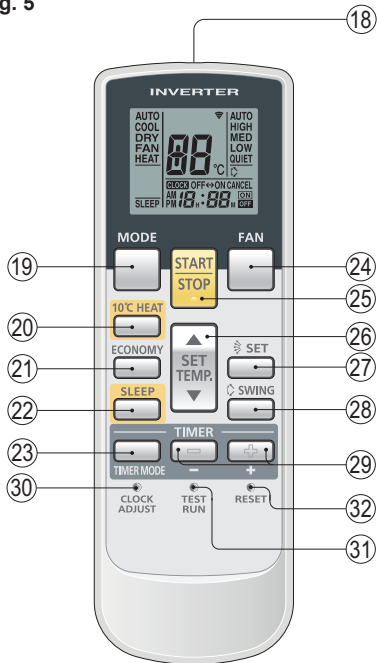

Fig. 6

To facilitate explanation, the accompanying illustration has been drawn to show all possible indicators; in actual operation, however, the display will only show those indicators appropriate to the current operation.

Fig. 1 Indoor Unit

- ① **Operating Control Panel (Fig. 2)**
- ② **Air Outlet Selection switch**
- ③ **MANUAL AUTO button**
 - When the MANUAL AUTO button is pressed in for more than 10 seconds, the forced cooling operation will start.
 - The forced cooling operation is used at the time of installation.
Only for authorized service personnel's use.
 - When the forced cooling operation starts by any chance, press the START/STOP button to stop the operation.
- ④ **Indicator (Fig. 3)**
- ⑤ **Remote Control Signal Receiver**
- ⑥ **OPERATION Indicator Lamp (green)**
- ⑦ **TIMER Indicator Lamp (orange)**
 - If the TIMER indicator lamp flashes when the timer is operating, it indicates that a fault has occurred with the timer setting (See Page 16 Auto Restart).
- ⑧ **ECONOMY Indicator Lamp (green)**
- ⑨ **Intake Grille (Fig. 4)**
- ⑩ **Front Panel**
- ⑪ **Air Filter**
- ⑫ **Airflow Direction Louver**
- ⑬ **Damper**
- ⑭ **Right-Left Louver
(behind Airflow Direction Louver and Damper)**
- ⑮ **Drain Hose**
- ⑯ **Air Cleaning Filter**
- ⑰ **Rope**

Fig. 5 Remote Controller

- ⑱ **Signal Transmitter**
- ⑲ **MODE button**
- ⑳ **10°C HEAT button**
- ㉑ **ECONOMY button**
- ㉒ **SLEEP button**
- ㉓ **TIMER MODE button**
- ㉔ **FAN button**
- ㉕ **START/STOP button**
- ㉖ **SET TEMP. button (▲ / ▼)**
- ㉗ **SET button**
- ㉘ **SWING button**
- ㉙ **TIMER SET ([+] / [-]) button**
- ㉚ **CLOCK ADJUST button**
- ㉛ **TEST RUN button**
 - This button is used when installing the conditioner, and should not be used under normal conditions, as it will cause the air conditioner's thermostat function to operate incorrectly.
 - If this button is pressed during normal operation, the unit will switch to test operation mode, and the Indoor Unit's OPERATION Indicator Lamp and TIMER Indicator Lamp will begin to flash simultaneously.
 - To stop the test operation mode, press the START/STOP button to stop the air conditioner.
- ㉜ **RESET button**
- ㉝ **Remote Controller Display (Fig. 6)**
- ㉞ **Temperature SET Display**
- ㉟ **Operating Mode Display**
- ㊱ **SLEEP Display**
- ㊲ **Transmit Indicator**
- ㊳ **Fan Speed Display**
- ㊴ **SWING Display**
- ㊵ **Timer Mode Display**
- ㊶ **Clock Display**

PREPARATION

Load Batteries (Size AAA R03/LR03 × 2) *

1 Press and slide the battery compartment lid on the reverse side to open it.

Slide in the direction of the arrow while pressing the  mark.

* Batteries are not included with this product.

2 Insert batteries.

Be sure to align the battery polarities (\oplus/\ominus) correctly.

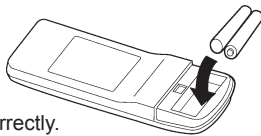

3 Close the battery compartment lid.

Set the Current time

1 Press the CLOCK ADJUST button (Fig. 5 30).

Use the tip of a ball-point pen or other small object to press the button.

2 Use the TIMER SET (\oplus / \ominus) buttons (Fig. 5 29) to adjust the clock to the current time.

 button: Press to advance the time.

 button: Press to reverse the time.

(Each time the buttons are pressed, the time will be advanced/reversed in 1 minute increments; hold the buttons depressed to change the time quickly in 10 minute increments.)

3 Press the CLOCK ADJUST button (Fig. 5 30) again.

This completes the time setting and starts the clock.

To Use the Remote Controller

- The Remote Controller must be pointed at signal receiver (Fig. 1 5) to operate correctly.
- Operating Range: About 7 meters.
- When a signal is properly received by the air conditioner, a beeping sound will be heard.
- If no beep is heard, press the Remote Controller button again.

Remote Controller Holder

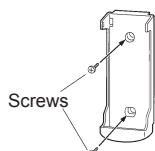

① Mount the Holder.

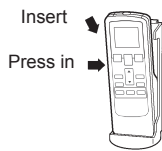

② Set the Remote Controller.



③ To remove the Remote Controller (when use at hand).

⚠ CAUTION!

- Take care to prevent infants from accidentally swallowing batteries.
- When not using the Remote Controller for an extended period, remove the batteries to avoid possible leakage and damage to the unit.
- If leaking battery fluid comes in contact with your skin, eyes, or mouth, immediately wash with copious amounts of water, and consult your physician.
- Dead batteries should be removed immediately and disposed of properly, either in a battery collection receptacle or to the appropriate authority.
- Do not attempt to recharge dry batteries.

Never mix new and used batteries, or batteries of different types.

Batteries should last about 1 year under normal use. If the Remote Controller's operating range becomes appreciably reduced, replace the batteries and press the RESET button with the tip of a ball-point pen or other small object.

OPERATION

To Select Mode Operation

- 1 Press the START/STOP button (Fig.5 25).**
 The indoor unit's OPERATION Indicator Lamp (green) (Fig. 3 6) will light.
 The air conditioner will start operating.
- 2 Press the MODE button (Fig.5 19) to select the desired mode.**
 Each time the button is pressed, the mode will change in the following order.



About 3 seconds later, the entire display will reappear.

To Set the Thermostat

Press the SET TEMP. button (Fig. 5 26).

- ▲ button: Press to raise the thermostat setting.
- ▼ button: Press to lower the thermostat setting.

●Thermostat setting range:

AUTO	18-30 °C
Cooling/Dry	18-30 °C
Heating.....	16-30 °C

The thermostat cannot be used to set room temperature during the FAN mode (the temperature will not appear on the Remote controller's Display).

About 3 seconds later, the entire display will reappear.

The thermostat setting should be considered a standard value, and may differ somewhat from the actual room temperature.

To Set the Fan Speed

Press the FAN button (Fig. 5 24).

Each time the button is pressed, the fan speed changes in the following order:



About 3 seconds later, the entire display will reappear.

When set to AUTO:

- Heating** : Fan operates so as to optimally circulate warmed air.
 However, the fan will operate at very low speed when the temperature of the air issued from the indoor unit is low.
- Cooling** : As the room temperature approaches that of the thermostat setting, the fan speed becomes slower.
- Fan** : The fan runs at the low fan speed.

The fan will operate at a very low setting during Monitor operation and at the start of the Heating mode.

SUPER QUIET Operation

SUPER QUIET operation begins. The indoor unit's airflow will be reduced for quieter operation.

- SUPER QUIET operation cannot be used during Dry mode. (The same is true when dry mode is selected during AUTO mode operation.)
- During Super Quiet operation, Heating and Cooling performance will be reduced somewhat. If the room does not warm up/ cool down when using SUPER QUIET Operation, please adjust the air conditioner's Fan Speed.

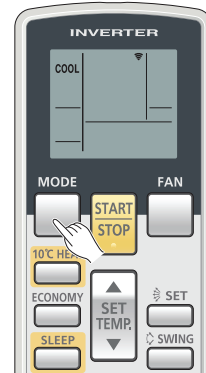

Example: When set to COOL.

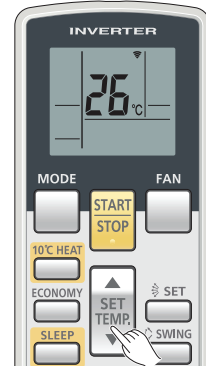

Example: When set to 26 °C.

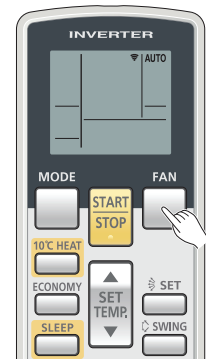

Example: When set to AUTO.

To Stop Operation

Press the START/STOP button (Fig. 5 ㉔).

The OPERATION Indicator Lamp (green) (Fig. 3 ㉖) will go out.

About AUTO CHANGEOVER Operation

AUTO: ● When AUTO CHANGEOVER operation first selected, the fan will operate at very low speed for about a few minutes, during which time the indoor unit detects the room conditions and selects the proper operation mode.

If the difference between thermostat setting and actual room temperature is more than +2 °C → Cooling or dry operation

If the difference between thermostat setting and actual room temperature is within ±2 °C → Determined by outdoor temperature

If the difference between thermostat setting and actual room temperature is more than -2 °C → Heating operation

- When the indoor unit has adjusted your room's temperature to near the thermostat setting, it will begin monitor operation. In the monitor operation mode, the fan will operate at low speed. If the room temperature subsequently changes, the indoor unit will once again select the appropriate operation (Heating, Cooling) to adjust the temperature to the value set in the thermostat.
- If the mode automatically selected by the indoor unit is not what you wish, select one of the mode operation (HEAT, COOL, DRY, FAN).

About Mode Operation

Heating: ● Use to warm your room.

- When Heating mode is selected, the air conditioner will operate at very low fan speed for about 3 to 5 minutes, after which it will switch to the selected fan setting. This period of time is provided to allow the indoor unit to warm up before begin full operation.
- When the outdoor temperature is very low, frost may form on the outside unit, and its performance may be reduced. In order to remove such frost, the unit will automatically enter the defrost cycle from time to time. During Automatic Defrosting operation, the OPERATION Indicator Lamp (Fig. 3 ㉖) will flash, and the heat operation will be interrupted.

Cooling: ● Use to cool your room.

Dry: ● Use for gently cooling while dehumidifying your room.

- You cannot heat the room during Dry mode.
- During Dry mode, the unit will operate at low speed; in order to adjust room humidity, the indoor unit's fan may stop from time to time. Also, the fan may operate at very low speed when adjusting room humidity.
- The fan speed cannot be changed manually when Dry mode has been selected.

Fan: ● Use to circulate the air throughout your room.

During Heating mode:

Set the thermostat to a temperature setting that is higher than the current room temperature. The Heating mode will not operate if the thermostat is set lower than the actual room temperature.

During Cooling/Dry mode:

Set the thermostat to a temperature setting that is lower than the current room temperature. The Cooling and Dry modes will not operate if the thermostat is set higher than the actual room temperature (in Cooling mode, the fan alone will operate).

During Fan mode:

You can not use the unit to heat and cool your room.

TIMER OPERATION

Before using the timer function, be sure that the Remote Controller is set to the correct current time (☞ P. 5).

To Use the ON timer or OFF timer

1 Press the START/STOP button (Fig. 5 ㉔)
(if the unit is already operating, proceed to step 2).
The indoor unit's OPERATION Indicator Lamp (green) (Fig. 3 ㉔) will light.

2 Press the TIMER MODE button (Fig. 5 ㉓) to select the OFF timer or ON timer operation.
Each time the button is pressed the timer function changes in the following order:

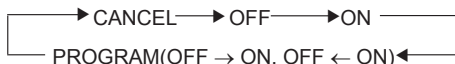

The indoor unit's green TIMER Indicator Lamp (orange) (Fig. 3 ㉗) will light.

3 Use the TIMER SET buttons (Fig. 5 ㉚) to adjust the desired OFF time or ON time.
Set the time while the time display is flashing (the flashing will continue for about 5 seconds).

[+] button: Press to advance the time.

[-] button: Press to reverse the time.

About 5 seconds later, the entire display will reappear.

To Cancel the Timer

Use the TIMER button to select "CANCEL".
The air conditioner will return to normal operation.

To Change the Timer Settings

Perform steps 2 and 3.

To Stop Air Conditioner Operation while the Timer is Operating

Press the START/STOP button.

To Change Operating Conditions

If you wish to change operating conditions (Mode, Fan Speed, Thermostat Setting, SUPER QUIET mode), after making the timer setting wait until the entire display reappears, then press the appropriate buttons to change the operating condition desired.

To Use the Program timer

1 Press the START/STOP button (Fig. 5 ㉔).
(if the unit is already operating, proceed to step 2).
The indoor unit's OPERATION Indicator Lamp (green) (Fig. 3 ㉔) will light.

2 Set the desired times for OFF timer and ON timer.
See the section "To Use the ON timer or OFF timer" to set the desired mode and times.
About 3 seconds later, the entire display will reappear.
The indoor unit's TIMER Indicator Lamp (orange) (Fig. 3 ㉗) will light.

3 Press the TIMER MODE button (Fig. 5 ㉓) to select the PROGRAM timer operation (OFF → ON or OFF ← ON will display).

The display will alternately show "OFF timer" and "ON timer", then change to show the time setting for the operation to occur first.

- The program timer will begin operation. (If the ON timer has been selected to operate first, the unit will stop operating at this point.)

About 5 seconds later, the entire display will reappear.

To Cancel the Timer

Use the TIMER MODE button to select "CANCEL".
The air conditioner will return to normal operation.

To Change the Timer Settings

1. Follow the instructions given in the section "To Use the ON Timer or OFF Timer" to select the timer setting you wish to change.
2. Press the TIMER MODE button to select either OFF → ON or OFF ← ON.

To Stop Air Conditioner Operation while the Timer is Operating

Press the START/STOP button.

To Change Operating Conditions

If you wish to change operating conditions (Mode, Fan Speed, Thermostat Setting, SUPER QUIET mode), after making the timer setting wait until the entire display reappears, then press the appropriate buttons to change the operating condition desired.

About the Program timer

- The program timer allows you to integrate OFF timer and ON timer operations in a single sequence. The sequence can involve 1 transition from OFF timer to ON timer, or from ON timer to OFF timer, within a 24 hour period.
- The first timer function to operate will be the 1 set nearest to the current time. The order of operation is indicated by the arrow in the Remote controller's Display (OFF → ON, or OFF ← ON).
- One example of Program timer use might be to have the air conditioner automatically stop (OFF timer) after you go to sleep, then start (ON timer) automatically in the morning before you arise.

SLEEP TIMER OPERATION

Unlike other timer functions, the SLEEP timer is used to set the length of time until air conditioner operate is stopped.

To Use the SLEEP Timer

While the air conditioner is operating or stopped, press the SLEEP button (Fig. 5 ㉒).

The indoor unit's OPERATION Indicator Lamp (green) (Fig. 3 ㉖) lights and the TIMER Indicator Lamp (orange) (Fig. 3 ㉗) light.

To Cancel the Timer:

Use the TIMER MODE button to select "CANCEL".

The air conditioner will return to normal operation.

To Change the Timer Settings

Press the SLEEP button (Fig. 5 ㉒) once again and set the time using the TIMER SET (+ / -) buttons (Fig. 5 ㉓).

Set the time while the Timer Mode Display is flashing (the flashing will continue about 5 seconds).

+ button: Press to advance the time.

- button: Press to reverse the time.

About 5 seconds later, the entire display will reappear.

About the SLEEP Timer

To prevent excessive warming or cooling during sleep, the SLEEP timer function automatically modifies the thermostat setting in accordance with the set time setting. When the set time has elapsed, the air conditioner completely stops.

During Heating operation:

When the SLEEP timer is set, the thermostat setting is automatically lowered 1 °C every 30 minutes. When the thermostat has been lowered a total of 4 °C, the thermostat setting at that time is maintained until the set time has elapsed, at which time the air conditioner automatically turns off.

During Cooling/Dry operation:

When the SLEEP timer is set, the thermostat setting is automatically raised 1 °C every 1 hour. When the thermostat has been raised a total of 2 °C, the thermostat setting at that time is maintained until the set time has elapsed, at which time the air conditioner automatically turns off.

SLEEP timer setting

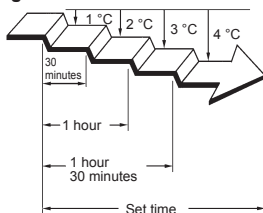

SLEEP timer setting

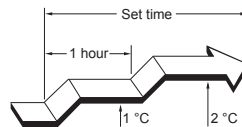

ADJUSTING THE DIRECTION OF AIR CIRCULATION

Vertical (up-down) direction of airflow is adjusted by pressing the Remote controller's SET button. Horizontal (right-left) airflow direction is adjusted manually, by moving the Airflow Direction Louvers.

Whenever making horizontal airflow adjustments, start air conditioner operation and be sure that the vertical air direction louvers are stopped.

Vertical Air Direction Adjustment

Press the SET button (Fig. 5 27).

Each time the button is pressed, the air direction range will change as follows:



The Remote controller's display does not change.

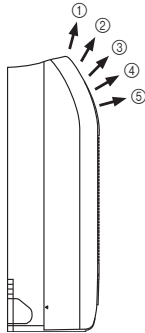

- Use the air direction adjustments within the ranges shown above.
- The vertical airflow direction is set automatically as shown, in accordance with the type of operation selected.
 - During Cooling/Dry mode : Upward flow ①
 - During Heating mode : Horizontal flow ④
- During AUTO mode operation, for the first minute after beginning operation, airflow will be upward ①; the air direction cannot be adjusted during this period.
- During Heating mode operation, airflow will be upward ① when the temperature of the air issued from the indoor is low.

⚠ WARNING!

- Never place fingers or foreign objects inside the outlet ports, since the internal fan operates at high speed and could cause personal injury.

- Always use the Remote controller's SET button to adjust the vertical airflow louvers. Attempting to move them manually could result in improper operation; in this case, stop operation and restart. The louvers should begin to operate properly again.
- When used in a room with infants, children, elderly or sick persons, the air direction and room temperature should be considered carefully when making settings.
- When indoor unit is embedded in a wall, airflow is fixed to horizontal direction ⑤. Please ask the service personnel to perform the embedding in a wall.

Right-Left Adjustment

Adjust the Right-Left louvers.

- Move the Right-Left louvers to adjust airflow in the direction you prefer.

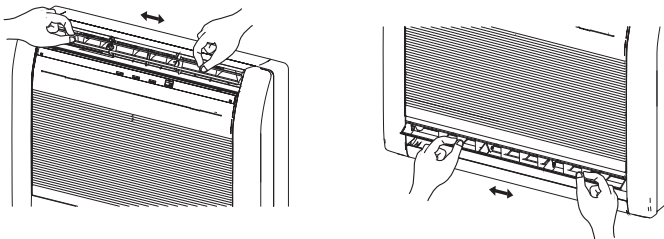

⚠ WARNING!

- Always adjust the Right-Left louvers when the damper is open. Opening the damper forcibly with hands can cause damper malfunction.

AIR OUTLET SELECTION

With this function, air comes out simultaneously from the upper and lower air outlets so that the room can be cooled or heated effectively. This function is set using the switch behind the front grille of the Indoor unit. (This function is available in cooling and heating operation.)

How to set to blow out air from the upper and lower air outlets

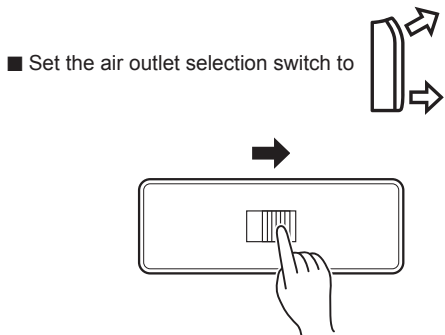





Air blows out automatically from the upper and lower air outlets as shown in the table below.

NOTE:

Set the air outlet selection switch to the end. Otherwise, air outlet cannot be selected as intended.

Description of operation

Operation	COOLING Mode		DRY Mode	HEATING Mode	
Airflow	 Upper and lower airflow	 Upper airflow	 Upper airflow only	 Upper and lower airflow	 Upper airflow
Conditions	Room temperature and set temperature are different.	Room temperature is close to set temperature, or the air conditioner has operated for 1 hour.	-	Airflow temperature is high.	Airflow temperature is low. (During defrosting operation, start of operation, etc.)

How to set to blow out air from the upper air outlet only

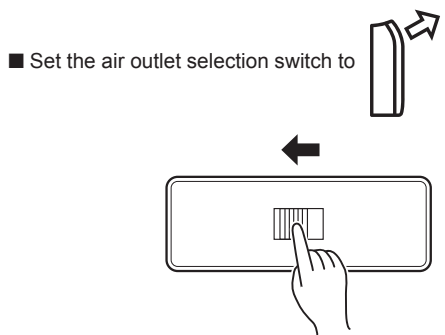

10°C HEAT OPERATION

- The room temperature can be maintained at 10°C by pressing the 10°C HEAT button (Fig.5 ㉔) so as to prevent the room temperature from falling too far.

To use 10°C HEAT OPERATION

Press the 10°C HEAT button (Fig.5 ㉔)

The OPERATION Indicator lamp (green)(Fig.3 ㉖) will go out, and the ECONOMY Indicator lamp (green)(Fig.3 ㉗) will light.

- The direction of airflow is set to horizontal.

While 10 °C HEAT OPERATION is in progress, only the following operation can be used.

- SET

To stop 10°C HEAT OPERATION

Press the START/STOP button (Fig.5 ㉕)

Then the operation stops.

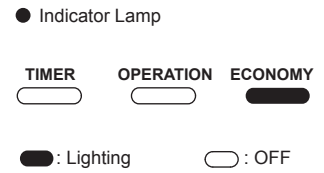

About the 10°C HEAT OPERATION

- The Heating mode will not operate if the room temperature is high enough.
- The room temperature can be maintained at 10 °C by pressing the 10 °C. HEAT button (Fig.5 ㉔) so as to prevent the room temperature from falling too far.
- In case of multi-type air conditioner, if other indoor unit is used for heating, the temperature of the room where the “10°C HEAT” function is applied will rise. When using the “10°C HEAT” mode, we recommend all indoor units should be run under the “10°C HEAT” mode.

ECONOMY OPERATION

Begin Air Conditioner operation before performing this procedure.

To Use the ECONOMY Operation

Press the ECONOMY button (Fig.5 ㉑).

The OPERATION Indicator lamp (green)(Fig.3 ㉖) and the ECONOMY Indicator lamp (green)(Fig.3 ㉗) will light.

Economy operation begins.

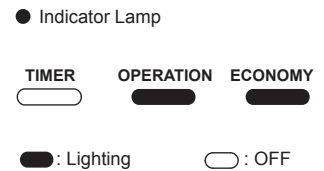

To Stop the ECONOMY Operation

Press the ECONOMY button (Fig.5 ㉑) again.

The ECONOMY Indicator lamp (green)(Fig.3 ㉗) will go out.

Normal operation begins.

About ECONOMY Operation

- When ECONOMY operation mode is operated, the room temperature will be little higher than the set-temp under cooling mode and lower than set-temp under heating mode. Therefore, the ECONOMY mode is able to save more energy than other normal mode.
- In case of single-type air conditioner, at the maximum output, ECONOMY operation is approximately 70% of normal air conditioner operation for cooling and heating.
- In case of multi-type air conditioner, the ECONOMY operation mode is only available for the set indoor unit.
- If the room is not cooled (or heated) well during ECONOMY operation, select normal operation.
- During the monitor period in the AUTO mode, the air conditioner operation will not change to ECONOMY operation even if ECONOMY operation is selected by pressing the ECONOMY operation button.

SWING OPERATION

Begin air conditioner operation before performing this procedure.

To select SWING Operation

Press the SWING button (Fig. 5 ㉘).

The SWING Display (Fig. 6 ㉙) will light.

In this mode, the Airflow Direction Louvers will swing automatically to direct the airflow both up and down.

To stop SWING Operation

Press the SWING button (Fig. 5 ㉘) once again.

The SWING Display (Fig. 6 ㉙) will go out.

Airflow direction will return to the setting before swing was begun.

About Swing Operation

Swings between ① and ⑤.

- The SWING operation may stop temporarily when the air conditioner's fan is not operating, or when operating at very low speeds.

MANUAL AUTO OPERATION

Use the MANUAL AUTO operation in the event the Remote Controller is lost or otherwise unavailable.

How To Use the Main Unit Controls

Press the MANUAL AUTO button (Fig. 2 ㉓) more than 3 seconds and less than 10 seconds on the main unit control panel.

To stop operation, press the MANUAL AUTO button (Fig. 2 ㉓) for 3 seconds.

- When the air conditioner is operated with the controls on the Main Unit, it will operate under the same mode as the AUTO mode selected on the Remote Controller (see page 6).
- The fan speed selected will be "AUTO" and the thermostat setting will be standard. (24°C)

CLEANING AND CARE



CAUTION!

- Before cleaning the air conditioner, be sure to turn it off.
- Be sure the Intake Grille (Fig. 1 ㉑) is installed securely.
- When removing and replacing the air filter, be sure not to touch the heat exchanger, as personal injury may result.

- To avoid excessive wear of the part and components or malfunctioning of the air conditioning, the user/consumer shall perform preventive maintenance through an accredited technical assistance, periodically. To know the preventive maintenance periodicity, the consumer shall check with the accredited installer or an accredited technical assistance.
- When used for extended periods, the unit may accumulate dirt inside, reducing its performance. We recommend that the unit be inspected regularly, in addition to your own cleaning and care. For more information, consult authorized service personnel.
- It is recommended for the user/consumer to demand a copy of the Work Order every time there is a visit of a technical assistance for verification, maintenance, test or repair of the product.
- When cleaning the unit's body, do not use water hotter than 40 °C, harsh abrasive cleansers, or volatile agents like benzene or thinner.
- Do not expose the unit body to liquid insecticides or hairsprays.
- When shutting down the unit for 1 month or more, first allow the fan mode to operate continuously for about one-half day to allow internal parts to dry thoroughly.

Cleaning the Intake Grille

1. Remove the Intake Grille.

- ① Place your fingers at both top indicator of the grille panel, and pull forward; if the grille seems to catch partway through its movement, continue pulling down to remove.
- ② Unhook the ropes which holds the grille.

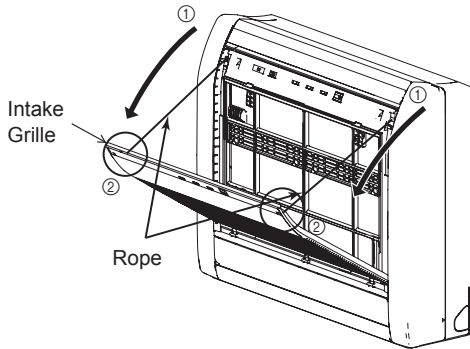

2. Clean with water.

Remove dust with a vacuum cleaner; wipe the unit with warm water, then dry with a clean, soft cloth.

3. Replace the Intake Grille.

- ① Hook the ropes.
- ② Set the left and right mounting shafts into the bearings at the bottom of the panel.
- ③ Press the place where the mark on the diagram indicates and close the Intake Grille.

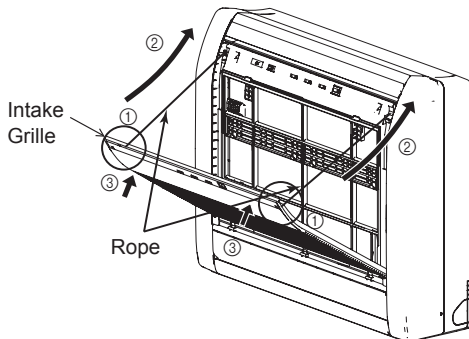

Cleaning the Air Filter

1. Open the Intake Grille, and remove the air filter.

Push down the air filter's handle, disconnect the 2 upper tabs, and pull out.

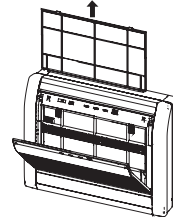

2. Remove dust with a vacuum cleaner or by washing.

After washing, allow to dry thoroughly in a shaded place.

3. Replace the Air Filter and close the Intake Grille.

- ① Align the sides of the air filter with the panel, and push in fully, making sure the 2 upper tabs are returned properly to their holes in the panel.

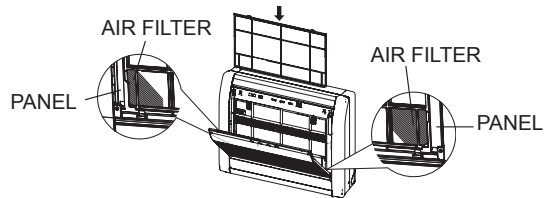

- ② Close the Intake Grille.

- Dust can be cleaned from the air filter either with a vacuum cleaner, or by washing the filter in a solution of mild detergent and warm water. If you wash the filter, be sure to allow it to dry thoroughly in a shady place before reinstalling.
- If dirt is allowed to accumulate on the air filter, airflow will be reduced, lowering operating efficiency and increasing noise.
- During periods of normal use, the Air Filters should be cleaned every 2 weeks.

CLEANING AND CARE

Air Cleaning Filter Installation

1. Open the Intake Grille and remove the Air filter.



2. Install the Air cleaning filter set (set of 2).

Set the air cleaning filter into the panel.
Catch it on 5 places of picks.
(3 places of upper parts and lower part 2 places.)

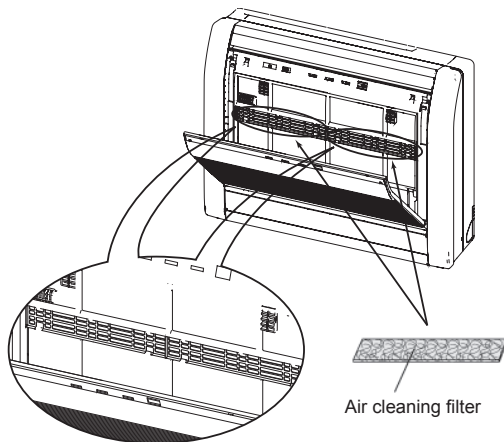

3. Install the Air filter and close the Intake Grille.

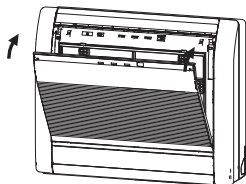

- When air cleaning filters are used, the effect will be increased by setting the fan speed to "High".

Replacing dirty Air cleaning filters

Replace filters with the following components (purchased separately).

- POLYPHENOL CATECHIN AIR CLEANING FILTER: UTR-FC03-2
- Negative air ions deodorizing filter: UTR-FC03-3

1. Open the Intake Grille and remove the Air filter.

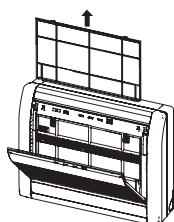

2. Replace them by 2 new Air cleaning filters.

- ① Remove the old air cleaning filters in reverse order of their installation.
- ② Install in the same way as for installation of the air cleaning filter set.

3. Install the Air filter and close the Intake Grille.

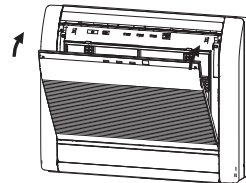

In regard to the Air Cleaning Filters

POLYPHENOL CATECHIN AIR CLEANING FILTER (1 sheet)

- The Air Cleaning Filters are disposable filters. (They can not be washed and reused.)
- For storage of the Air Cleaning Filters, use the filters as soon as possible after the package has been opened. (The air cleaning effect decreases when the filters are left in the opened package)
- Generally, the filters should be exchanged about every 3 months.

Please buy dedicated air cleaning filters (UTR-FC03-2) (Sold separately) to exchange the used dirty air cleaning filters.

[Negative air ions deodorizing filter (1 sheet) — light blue]

- The filters should be exchanged about every 3 years so as to maintain the deodorizing effect.

Please buy dedicated deodorizing filter (UTR-FC03-3) (Sold separately) when exchanging the filters.

Maintenance of Deodorizing Filters

In order to maintain the deodorizing effect, please clean the filter in the follow way once 3 months.

- ① Remove the deodorizing filter.
- ② Clean with water and dry in the air.
 - 1) Flush the filters with high-pressure hot water until the surface of the filters are covered with water. Please flush with diluent neutral detergent.

(Never wash by reaming or rubbing, otherwise it will damage the deodorizing effect.)
 - 2) Rinse with water flow.
 - 3) Dry in shade.
- ③ Reinstall the deodorizing filter.

Filter Indicator Reset (The special setting)

Can be used if set correctly during installation.
Please consult authorized serviceman when using this function.

- It lights on when it is time to clean the air filters. Clean the filter referring to "CLEANING AND CARE". After cleaning, press the MANUAL AUTO button (Fig.2 ③) for 2 seconds or less on the indoor unit.

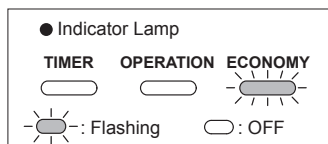

SELECTING THE REMOTE CONTROLLER SIGNAL CODE

When two or more air conditioners are installed in a room and the Remote Controller is operating an air conditioner other than the one you wish to set, change the signal code of the Remote Controller to operate only the air conditioner you wish to set (4 selections possible). When two or more air conditioners are installed in a room, please contact your retailer to set the individual air conditioner signal codes.

Selecting the Remote Controller Signal Code

Use the following steps to select the signal code of the Remote Controller. (Note that the air conditioner cannot receive a signal code if the air conditioner has not been set for the signal code.)

- 1 Press the START/STOP button until only the clock is displayed on the Remote Controller display.**
- 2 Press the MODE button for at least five seconds to display the current signal code (initially set to A).**
- 3 Press the (▲ / ▼) buttons to change the signal code between A→B→C→D. Match the code on the display to the air conditioner signal code.**
- 4 Press the MODE button again to return to the clock display. The signal code will be changed.**

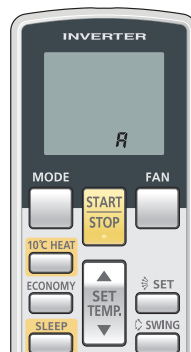

- If no buttons are pressed within 30 seconds after the signal code is displayed, the system returns to the original clock display. In this case, start again from step 1.
- The air conditioner signal code is set to A prior to shipment. Contact your retailer to change the signal code.
- The Remote Controller resets to signal code A when the batteries in the Remote Controller are replaced. If you use a signal code other than signal code A, reset the signal code after replacing the batteries.
If you do not know the air conditioner signal code setting, try each of the signal codes (A→B→C→D) until you find the code which operates the air conditioner.

TROUBLESHOOTING

WARNING!

In the event of a malfunction (burning smell, etc.), immediately stop operation, turn off the electrical breaker or disconnect the power supply plug, and consult authorized service personnel. Merely turning off the unit's power switch will not completely disconnect the unit from the power source. Always be sure to turn off the electrical breaker or disconnect the power supply plug to ensure that power is completely off.

Before requesting service, perform the following checks:

	Symptom	Problem	See Page
NORMAL FUNCTION	Doesn't operate immediately:	<ul style="list-style-type: none"> ● If the unit is stopped and then immediately started again, the compressor will not operate for about 3 minutes, in order to prevent fuse blowouts. ● Whenever the electrical breaker is turned off than on again or the power supply plug is disconnected and then reconnected, the protection circuit will operate for about 3 minutes, preventing unit operation during that period. 	—
	Noise is heard:	<ul style="list-style-type: none"> ● During operation and immediately after stopping the unit, the sound of water flowing in the air conditioner's piping may be heard. Also, noise may be particularly noticeable for about 2 to 3 minutes after starting operation (sound of coolant flowing). ● During operation, a slight squeaking sound may be heard. This is the result of minute expansion and contraction of the front panel due to temperature changes. 	—
		<ul style="list-style-type: none"> ● During Heating operation, a sizzling sound may be heard occasional. This sound is produced by the Automatic Defrosting operation. 	19
	Smells:	<ul style="list-style-type: none"> ● Some smell may be emitted from the indoor unit. This smell is the result of room smells (furniture, tobacco, etc.) which have been taken into the indoor unit. 	—
	Mist or steam are emitted:	<ul style="list-style-type: none"> ● During Cooling or Dry operation, a thin mist may be seen emitted from the indoor unit. This results from the sudden Cooling of room air by the air emitted from the indoor unit, resulting in condensation and misting. 	—
		<ul style="list-style-type: none"> ● During Heating operation, the outdoor unit's fan may stop, and steam may be seen rising from the unit. This is due to Automatic Defrosting operation. 	19
	Airflow is weak or stops:	<ul style="list-style-type: none"> ● When Heating operation is started, fan speed is temporarily very low, to allow internal parts to warm up. ● During Heating operation, if the room temperature rises above the thermostat setting, the outdoor unit will stop, and the indoor unit will operate at very low fan speed. If you wish to warm the room further, set the thermostat for a higher setting. 	—
		<ul style="list-style-type: none"> ● During Heating operation, the unit will temporarily stop operation (Max. 15 minutes) as the Automatic Defrosting mode operates. During Automatic Defrosting operation, the OPERATION Indicator Lamp will flash. 	19
		<ul style="list-style-type: none"> ● The fan may operate at very low speed during Dry operation or when the unit is monitoring the room's temperature. 	6 - 7
		<ul style="list-style-type: none"> ● During SUPER QUIET operation, the fan will operate at very low speed. 	6
		<ul style="list-style-type: none"> ● In the monitor AUTO operation, the fan will operate at very low speed. 	7
		<ul style="list-style-type: none"> ● In case of Multi-type unit, if multiple units are operated in different operation modes as shown below, the units operated afterward will stop and the OPERATION indicator lamp (green) will flash. Heating mode and cooling mode (or dry mode) Heating mode and fan mode 	20
		<ul style="list-style-type: none"> ● During Heating operation, water may be produced from the outdoor unit due to Automatic Defrosting operation. 	19

TROUBLESHOOTING

	Symptom	Problem	See Page
NORMAL FUNCTION	The damper opens and closes automatically	<ul style="list-style-type: none"> ● The damper is automatically controlled by a microcomputer according to the airflow temperature and operation time of the air conditioner. 	—

	Symptom	Items to check	See Page
CHECK ONCE MORE	Doesn't operate at all:	<ul style="list-style-type: none"> ● Has the circuit breaker been turn off? ● Has there been a power failure? ● Has a fuse blown out, or a circuit breaker been tripped? 	—
		<ul style="list-style-type: none"> ● Is the timer operating? 	8 - 9
	Poor Cooling (or Heating) performance:	<ul style="list-style-type: none"> ● Is the Air Filter dirty? ● Air the air conditioner's intake grille or outlet port blocked? ● Did you adjust the room temperature settings (thermostat) correctly? ● Is there a window or door open? ● In the case of Cooling operation, is a window allowing bright sunlight to enter? (Close the curtains.) ● In the case of Cooling operation, are there heating apparatus and computers inside the room, or are there too many people in the room? ● Make sure the lower air outlet is not choked with foreign matters, causing abnormal operation to damper. 	—
		<ul style="list-style-type: none"> ● Is the unit set for SUPER QUIET operation? 	6
The unit operates differently from the Remote controller's setting:	<ul style="list-style-type: none"> ● Are the Remote controller's batteries dead? ● Are the Remote controller's batteries loaded properly? 	5	

If the problem persists after performing these checks, or if you notice burning smells, or the OPERATION Indicator Lamp (Fig. 3 ⑥) and the TIMER Indicator Lamp (Fig. 3 ⑦) flashes, and ECONOMY Indicator Lamp (Fig.3 ⑧) flashes fast. Immediately stop operation, turn off the electrical breaker and consult authorized service personnel.

OPERATING TIPS

Operation and Performance

Heating Performance

- This air conditioner operates on the heat-pump principle, absorbing heat from outdoor air and transferring that heat indoors. As a result, the operating performance is reduced as outdoor air temperature drops. If you feel that insufficient heating performance is being produced, we recommend you use this air conditioner in conjunction with another kind of heating appliance.
- Heat-pump air conditioners heat your entire room by circulating air throughout the room, with the result that some time may be required after first starting the air conditioner until the room is heated.

Microcomputer-controlled Automatic Defrosting

- When using the Heating mode under conditions of low outdoor temperature and high humidity, frost may form on the outdoor unit, resulting in reduced operating performance.
In order to prevent this kind of reduced performance, this unit is equipped with a Microcomputer-controlled Automatic Defrosting function. If frost forms, the air conditioner will temporarily stop, and the defrosting circuit will operate briefly (Max. 15 minutes).
During Automatic Defrosting operation, the OPERATION Indicator Lamp (green) will flash.
- After heating operation stops, if frost forms on the outdoor unit, the unit will start Automatic Defrosting operation. At this time, the outdoor unit will automatically stop after operating for a few minutes.
(However, some type of multi-type air conditioner doesn't provide this function.)

AUTO Restart

In Event of Power Interruption

- The air conditioner power has been interrupted by a power failure. The air conditioner will then restart automatically in its previous mode when the power is restored.
- If a power failure occurs during TIMER operation, the timer will be reset and the unit will begin (or stop) operation at the new time setting. In the event that this kind of timer fault occurs the TIMER Indicator Lamp will flash (see Page. 3).
- Use of other electrical appliances (electric shaver, etc.) or nearby use of a wireless radio transmitter may cause the air conditioner to malfunction. In this event, temporarily disconnect the Power Supply Plug, reconnect it, and then use the Remote Controller to resume operation.

OPERATING TIPS

Multi-type Air conditioner

This indoor unit can be connected to a multi-type outdoor unit depending on model. The multi-type air conditioner allows multiple indoor units to be operated in multiple locations. The indoor units may be operated simultaneously, in accordance with their respective output.

Simultaneous Use of Multiple Units

- When using a multi-type air conditioner, the multiple indoor units can be operated simultaneously, but when two or more indoor units of the same group are operated simultaneously, the heating and cooling efficiency will be less than when a single indoor unit is used alone. Accordingly, when you wish to use more than 1 indoor unit for cooling at the same time, the use should be concentrated at night and other times when less output is required. In the same way, when multiple units are used simultaneously for heating, it is recommended that they be used in conjunction with other auxiliary space heaters, as required.
- Seasonal and outdoor temperature conditions, the structure of the rooms and the number of persons present may also result in differences of operating efficiency. We recommend that you try various operating patterns in order to confirm the level of heating and cooling output provided by your units, and use the units in the way that best matches your family's lifestyle.
- If you discover that one or more units delivers a low level of cooling or heating during simultaneous operation, we recommend that you stop simultaneous operation of the multiple units.
- Operation cannot be done in the following different operating modes.
If the indoor unit is instructed to do an operating mode that it cannot perform, the OPERATION indicator lamp (green) on the indoor unit will flash (1 second on, 1 second off) and the unit will go into the standby mode.
 - Heating mode and cooling mode (or dry mode)
 - Heating mode and fan mode
- Operation can be done in the following different operating modes.
 - Cooling mode and dry mode
 - Cooling mode and fan mode
 - Dry mode and fan mode
- The operating mode (heating mode or cooling (dry) mode) of the outdoor unit will be determined by the operating mode of the indoor unit that was operated first. If the indoor unit was started in fan mode, the operating mode of the outdoor unit will not be determined.
For example, if indoor unit (A) was started in fan mode and then indoor unit (B) was then operated in heating mode, indoor unit (A) would temporarily start operation in fan mode but when indoor unit (B) started operating in heating mode, the OPERATION indicator lamp (green) for indoor unit (A) would begin to flash (1 second on, 1 second off) and it would go into standby mode. Indoor unit (B) would continue to operate in heating mode.

Notice

- During use of the heating mode, the outdoor unit will occasionally commence the defrost operation for brief periods. During the defrosting operation, if the user sets the indoor unit for heating again, the defrosting mode will continue, and the heating operation will begin after completion of defrosting, with the result that some time may be required before warm air is emitted.
- During use of the heating mode, the top of the indoor unit may become warm, but this is due to the fact that coolant is circulated through the indoor unit even when it is stopped; it is not a malfunction.